

MAURER

Expansion Joints

State of the art of sustainable solutions



Content

| | |
|-------------------------------------|--------------|
| >> EXPERIENCE IN INNOVATION | P. 03 |
| >> EXPANSION JOINTS | P. 04 |
| Solutions for any application | P. 04 |
| >> RAILROAD EXPANSION JOINTS | P. 06 |
| Single Mat Joints | P. 06 |
| Multiple Mat Joints | P. 06 |
| Guided Cross-Tie | P. 06 |
| >> ADD-ONS | P. 07 |
| >> ROADWAY EXPANSION JOINTS | P. 08 |
| Single Seal Joints | P. 08 |
| Modular Joints | P. 09 |
| Finger Joints | P. 10 |
| Anti-Skid | P. 10 |
| >> ADD-ONS AND SPECIALS | P. 11 |
| >> SEISMIC JOINTS | P. 12 |
| Girder Grid Joints | P. 12 |
| Swivel Joist Expansion Joints | P. 12 |
| Fuse Box for Modular Joints | P. 12 |
| >> ARCHITECTURAL JOINTS | P. 13 |
| Internal Floor Joints | P. 13 |
| Wall / Column Joints | P. 13 |
| Roof Joints | P. 13 |
| Parking / Landscape Joints | P. 13 |
| >> REFERENCES | P. 14 |
| >> QUALITY CONTROL | P. 15 |



Yavuz Sultan Selim Bridge, Turkey

Experience in Innovation

The MAURER Group is a leading specialist in mechanical engineering and steel construction and has been family-owned since it was formed back in 1876. At present, the MAURER Group is one of the global technological leaders in steel and plant construction in various specialist fields. We offer products, solutions and services which are particularly notable for their quality, durability and reliability.



MAURER headquarters, Munich / Germany

Five areas of application for a customized Structural Protection System

The protection of buildings, bridges and complex structures from damage caused by traffic, wind and seismic-induced movements can be controlled through selective use of structural bearings, expansion joints, tuned mass dampers, seismic devices and vibration isolation systems.

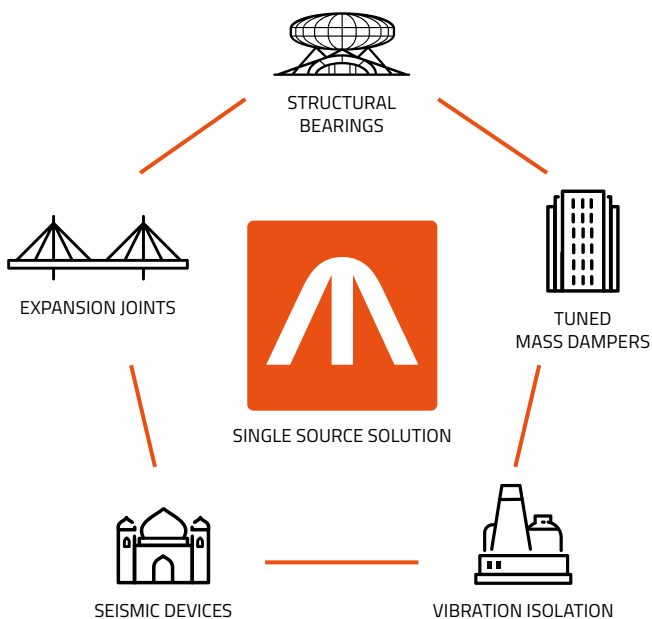

We also offer the following services:

>> SUPERVISION

- Inspection
- Maintenance
- Refurbishments
- Training courses

>> STATIC & DYNAMIC ANALYSIS

- FE analysis
- Component testing
- Design planning
- Monitoring

Expansion Joints

Expansion joints for bridges and building construction should accommodate any movements of the structures as far as possible without any constraints. The expansion joints can ensure operational safety and road safety under all known climatic and usage conditions.

>> Solutions for any application

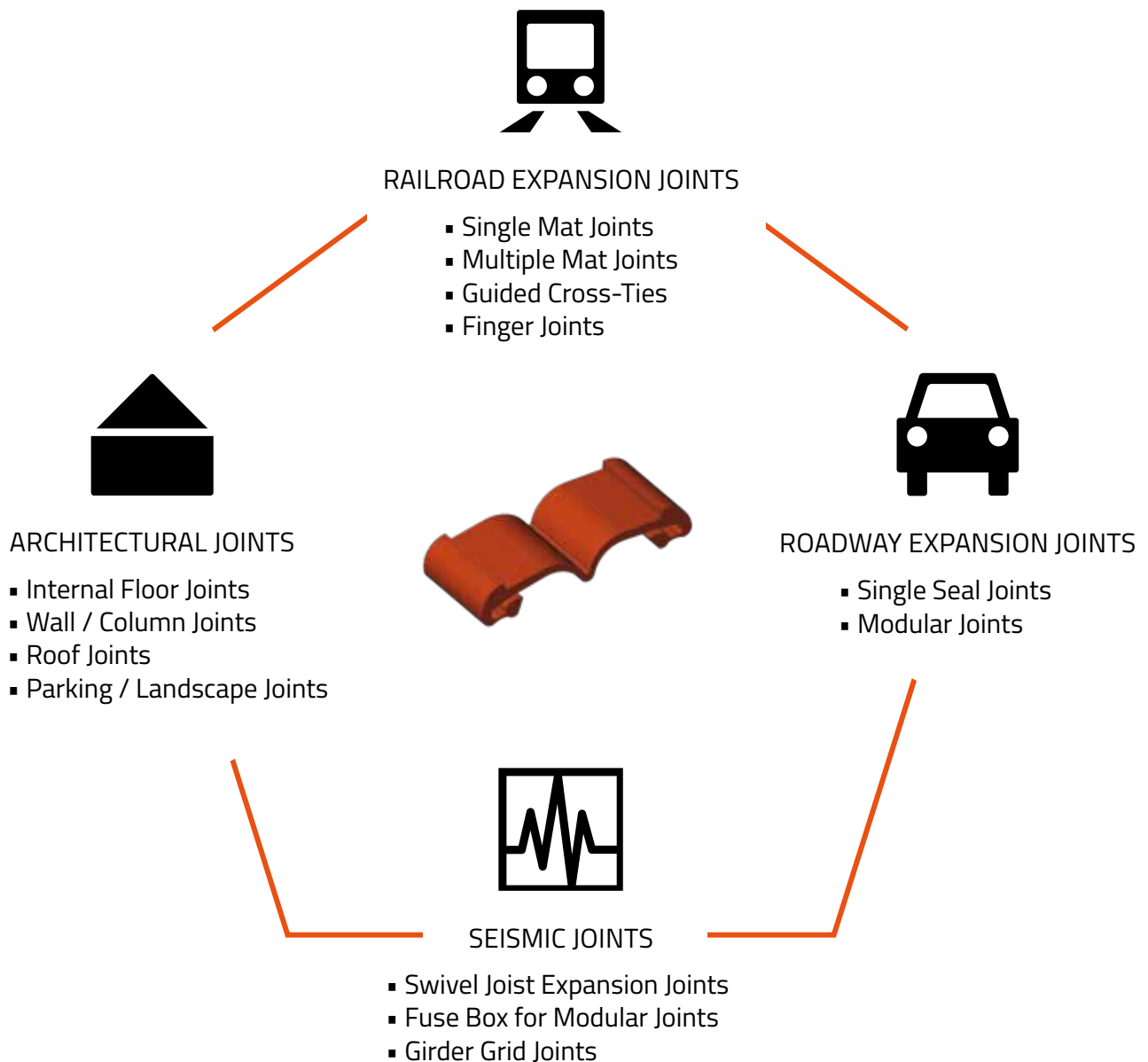

>> ROADWAY EXPANSION JOINTS 🚗

Roadway bridge expansion joints are designed to allow for continuous traffic between structures while accommodating movement caused by shrinkage/creeping and temperature variations on reinforced and prestressed concrete, composite and steel structures.



Waldschloesschen Bridge, Dresden / Germany



TGV railroad section near Avignon / France

>> RAILROAD EXPANSION JOINTS 🚂

Railroad bridges are different from roadway bridges. When trains pass a bridge, the traffic loads are higher, which means that the relation between dead load and live load is a different one compared to a roadway bridge. MAURER Deutsche Bahn Expansion Joints are authorized by the German Railroad Authority.

>> SEISMIC JOINTS 🏠

MAURER Seismic Expansion Joints feature reserves for extreme conditions. Seismic effects generate additional, in some cases significant increase of displacements that vary considerably from the service state in terms of their size, direction and velocity.



Russky Bridge, Vladivostok / Russia



Triumphal Arch in Bucharest / Romania

>> ARCHITECTURAL JOINTS 🏠

MAURER India Architectural Expansion Joints are versatile, economical and suitable for easy-to-use and maintain floor, wall and roof joint systems.

>> LEGEND

🚗 Road bridges

🚂 Railroad bridges

🏠 Building construction

🏠 Seismic protection

Railroad Expansion Joints



TGV railroad section near Avignon / France

Railroad bridges are designed for wheel set loads of up to standardized 250 kN, 315 kN or 350 kN (depending on the most frequently used codes) and speeds of up to 300 km/h. MAURER Railroad Joints can be adapted to highspeed traffic and railroad traffic as well. In railroad bridges, displacements between superstructures and abutments cause additional stress on the rails as well as strains on the rail fasteners.

>> Key characteristics of MAURER Railroad Expansion Joints

- ✓ Products are approved by the German Railroad Authority
- ✓ Durable and completely watertight
- ✓ Allowing movement in all directions without damages

>> Single Mat Joints < 130 mm

MAURER Single Mat Joints are basically made of a rubber profile fixed with aluminum clamp profiles. These joints have to be installed underneath the ballast.

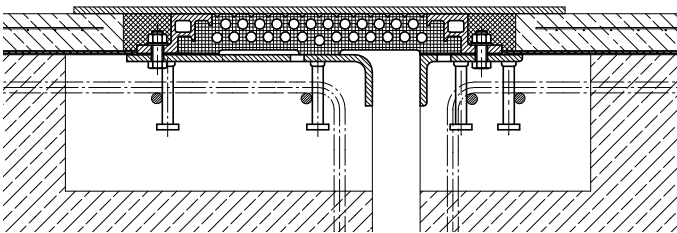

MAURER Single Mat Joint

>> Multiple Mat Joints < 260 mm

This system is a serial arranged Mat Joint.



Installation of MAURER Double Mat Joints



MAURER Guided Cross-Tie in test lab

>> Guided Cross-Tie < 1,600 mm

This unique MAURER Railroad Joint bridges large structural gaps by providing perfect load distribution and allows for flexibility in any direction. This joint will even accommodate any seismic movement without suffering from damages.

Add-ons

>> MAURER SLIDING PLATES

This MAURER Sliding Plate is designed for **small longitudinal movements and vertical rotations.**

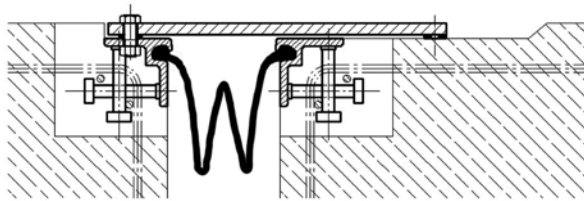

This MAURER Sliding Plate is designed for **medium to large longitudinal movements and vertical rotations.**

>> SINGLE SEAL AND MULTI SEAL ELASTO BLOC JOINTS

The MAURER Seal Elasto Bloc Joints allow for medium and large movements for single and multiple joints. They have been approved by Deutsche Bahn (DB).



>> SUPPORTING STEEL SLEEPER SYSTEM

The MAURER Supporting Steel Sleeper System allows for medium to large movements with a permanent maintainability.

Roadway Expansion Joints



Donnersberger Bridge, Munich / Germany

MAURER Roadway Expansion Joints on bridges are designed to allow for continuous traffic between structures while accommodating movement caused by shrinkage/creeping and temperature variations. These movements are enabled in any direction and structural gaps are covered in any service load case. In case of earthquakes, this type of joint can be adapted to the specific requirements (see page 12 MAURER Seismic Joints).

MAURER Seismic Joints are expansion joints featuring reserves for ultimate movements. In general, all MAURER Roadway Expansion Joints provide rigid anchoring with suitable concrete anchor loops. In addition, these joints are absolutely watertight because of a unique seal clamping system.

>> Key characteristics of MAURER Roadway Expansion Joints

- ✓ Absolutely watertight in any load condition
- ✓ Extremely low noise emission (reduction by 50–60%)
- ✓ Maintenance-free
- ✓ Long-term reliability (50 years according to technical approval)
- ✓ Optimal adjustment to structural geometry
- ✓ Quick return on investment (lowest life cycle cost in industry)

>> Single Seal Joints up to 100 mm

>> SINGLE SEAL JOINTS

MAURER Single Seal Expansion Joints are the best choice for small movements in longitudinal and/or transversal direction.

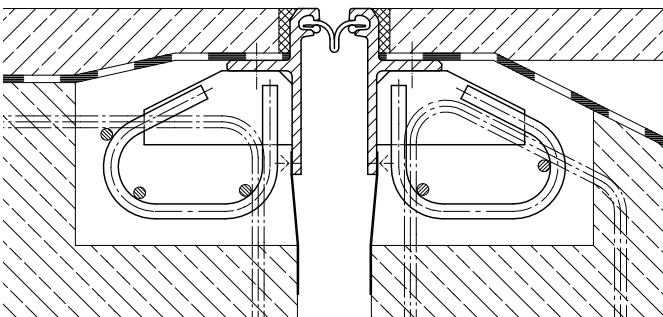

MAURER Single Seal Joint

>> LOW-NOISE SINGLE SEAL JOINTS

MAURER Expansion Joints for accommodating movements are based on the proven MAURER Single Seal Expansion Joints. The new wave-shaped geometry allows for a considerable reduction of the noise emission by at least 50–60%.



MAURER Low-Noise Single Seal Joint

>> SINGLE SEAL JOINTS WITH NOISE REDUCTION

MAURER Low-Noise Single Seal Joints with considerably enhanced noise reduction by up to 60% are designed for accommodating movements up to 110 mm.



MAURER Single Seal Joint with noise reduction

>> Modular Joints > 100 mm

MAURER Modular Expansion Joints for movements > 100 mm, also known as lamella joints, are the most common type of roadway joints used in road bridges worldwide. This highly flexible modular system enables adapting the number of lamellas to the structural requirements. Delivery as one unit ready for installation. No need for assembly on site. Results in considerable time savings. Easy pre-adjustment in the workshop. Any pre-set adjustments on site are possible.

>> GIRDER GRID EXPANSION JOINTS

MAURER Girder Grid Expansion Joints allow for significant longitudinal movement only and require a guided bearing system. This joint system is the most reliable and economical system with up to six seals.

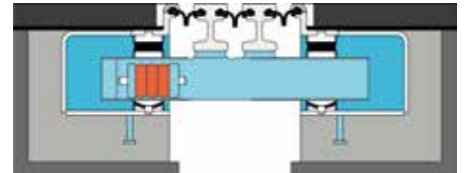

MAURER Girder Grid Joints



MAURER Swivel Joist Expansion Joints

>> SWIVEL JOIST EXPANSION JOINTS

MAURER Swivel Joist Expansion Joints are particularly suited for large and complex movements. By controlling each individual lamella separately, service and seismic movements of ± 1.5 m or even more can be accommodated to a large extent simultaneously in longitudinal and lateral direction.

>> SLIDING LAMELLA JOINTS

MAURER Sliding Lamella Joints are designed for easy installation into orthotropic steel decks and are the ideal system in case lane-by-lane replacement is required. Service and seismic movements of ± 1.5 m or even more in all three dimensions can be accommodated to a large extent simultaneously in longitudinal and lateral direction.



Inserting MAURER Sliding Lamella Joints into the structure

Roadway Expansion Joints

>> Finger Joints

According to local regulations, finger joints are either welded or bolted. MAURER Finger Joints are extremely safe both in the bolted and welded version. Lateral movements cannot be accommodated. Compared to standard lamella joints, MAURER Finger Joints have a minimum number of single components. The maintenance is mainly depending on the type of fixation.



Welded, maintenance-free

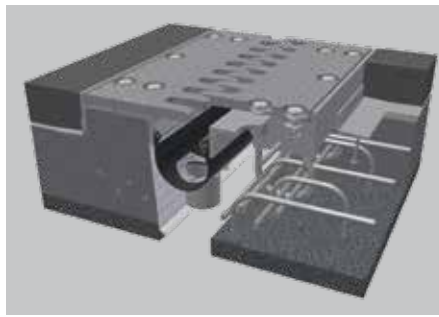

Prestressed, regular maintenance

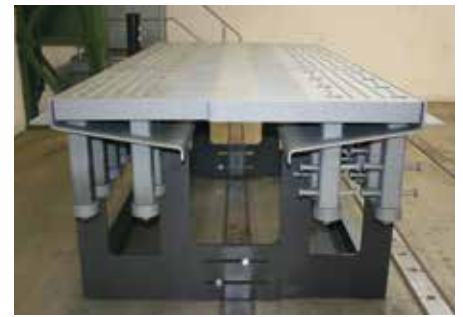

Neglectable maintenance – controlled prestress

>> Anti-Skid



Anti-Skid coating

>> TEMPORARY ANTI-SKID COATING

Anti-Skid is a surface paint treatment resulting in high roughness providing the Anti-Skid effect on the upper side of the lamella. The system durability is limited depending on the traffic load. The coating system can be renewed section-wise.

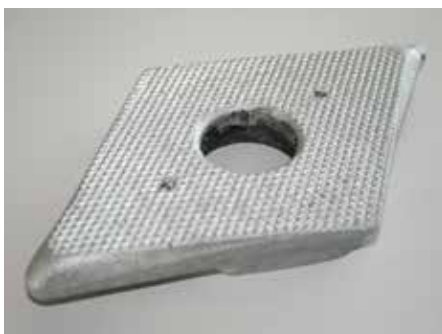

Durable Anti-Skid surface

>> DURABLE ANTI-SKID SURFACE

MAURER Low-Noise Expansion Joints allow to reduce the noise level by 50–60%. Additionally, the rhombic surface provides excellent Anti-Skid performance over the entire lifetime.

Add-ons and Specials

>> Add-ons

>> BETOFLEX®

MAURER Betoflex® Expansion Joints were especially developed for the requirements in road and bridge structures as well as for industrial buildings subjected to traffic loads. Betoflex® is a high-grade polymeric concrete and allows to glue the joint into the structural recess.

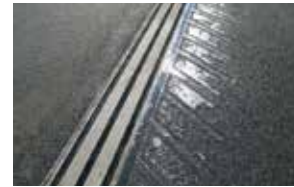

>> HYBRID PROFILE

MAURER Expansion Joints with hybrid profile type SW. The part that is in contact with the environment is made of stainless steel to avoid corrosion especially in salty environments.



>> CURVED UPTURN

By using a curved upturn, leakages in the lower elevation part of the joint are permanently prevented.

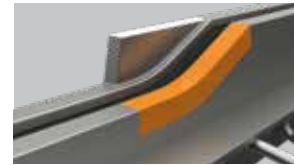

>> NOISE INSULATION BENEATH THE JOINT

The noise caused by overpassing traffic arising beneath the joint is effectively insulated with a special cover system under the joint. Noise reduction by at least 15–18 dB is possible. The system can be easily retrofitted and serviced.

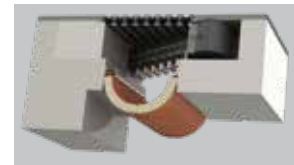

>> MONITORING

The MAURER Monitoring System (MMS) enables permanent monitoring of the load cases earthquake, traffic and wind. Forces, displacements, accelerations and temperatures which have an impact on the structure and the structural protection system are recorded. This data provides the basis for documenting loads, carrying out inspections and further enhancing the protection system.

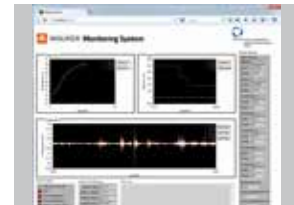

>> SLIDING PLATE JOINT

This joint is intended for structures not allowing for standard installation; instead, an existing recess has to be used for installation.

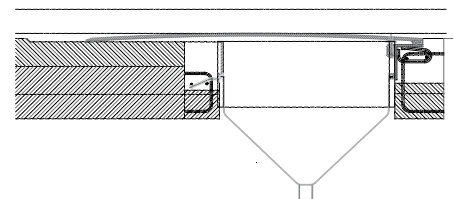

>> Specials

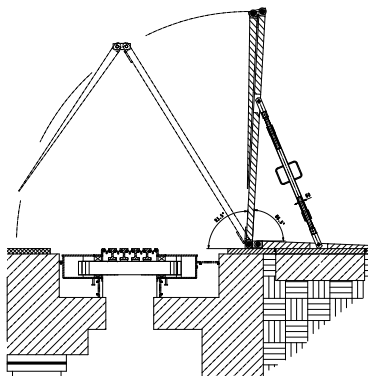

Opening and closing of the MAURER Modular Bridging System

>> MAURER MODULAR BRIDGING SYSTEM (MMBS)

The modular design of MMBS makes this new bridging system more flexible. According to customer specifications, the individual elements can be produced in different widths. Laid side by side, they function as an interim bridge allowing for crossing speeds of up to 70 km/h. Due to the modular structure, limited areas of the road can be released for work or opened for traffic. The MMBS is made of steel and, as a replacement for an expansion joint, compensates for thermal and dynamic deformations in longitudinal and transversal direction.

Seismic Joints



Kwang Ahn Grand Bridge, Korea

MAURER Seismic Joints accommodate the full seismic displacement either within the modular lamella system or within a Fuse Box device. Depending on the design of the structure, the no damage or limited damage criteria of the bridge deck are fulfilled. In general, traffic safety and overpassing after the earthquake is assured.

>> Girder Grid Joints

MAURER Girder Grid Expansion Joints enable large longitudinal movements. In transverse direction, the movement is limited to ± 20 mm and in vertical direction to ± 10 mm per lamella.



MAURER Girder Grid Joint



Craned MAURER Swivel Joist Modular Joint

>> Swivel Joist Expansion Joints

MAURER Swivel Joist Expansion Joints are the basis for any seismic joint. Based on this construction principle, the joint is designed for the required huge seismic displacements of ± 3 m or even larger in any direction without getting damaged at all.

>> Fuse Box for Modular Joints

When following this design approach, MAURER Swivel Joist Expansion Joints accommodate all service displacements without damages. For closing movements beyond the service capacity, the MAURER Fuse Box System will be activated. Depending on the fuse design, the joint will move either vertically upwards or horizontally in a designated, defined space. In case of seismic opening movements, the extended support bars protect the expansion joint from falling into the structural gap. After the earthquake, fast and simple repair of the predetermined breaking points within the MAURER Fuse Box System and its road surface is easily and quickly possible.

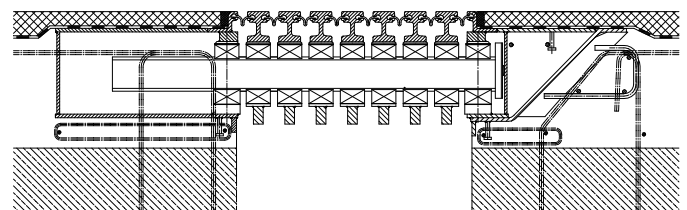

MAURER Fuse Box

>> Key characteristics of MAURER Seismic Joints

- ✓ Immediate overpassing of the joint after the earthquake is possible for emergency vehicles
- ✓ Limited or no damage criteria of the bridge deck are fulfilled
- ✓ Fuse Box System available for more economical design

Architectural Joints



Mumbai Airport, India

MAURER India Architectural Expansion Joints are versatile, economical and suitable for easy-to-use and maintain floor, wall and roof joint systems. They exhibit narrow sight lines, a unique fastening system, and reduce installation time. Systems with multi-cellular seal design support pedestrian traffic and offer sufficient flexibility to accommodate multidirectional structural movements and rotations. Systems with profiles and cover plates made of aluminum or stainless steel are ideal for large to very large seismic three-dimensional movements while supporting heavy pedestrian traffic.

>> Key characteristics of MAURER Architectural Joints

- ✓ Esthetically appealing
- ✓ Design flexibility
- ✓ Multidirectional movement for seismic applications
- ✓ Aluminum and stainless steel versions available

>> Internal Floor Joints < 320 mm

The MAURER SDPS model is durable and suitable for interior floor location of expansion control systems capable of accommodating multidirectional thermal and seismic movements. It is easy to install and flush with the floor finish.



MAURER SDPS model

>> Wall / Column Joints < 50 mm

The MAURER SNPG / SNJG Joint has a cover plate that is anchored in the substructure. The top plate can be supplied in various colors by powder coating or anodizing to match the décor.



MAURER SNPG / SNJG model

>> Roof Joints < 375 mm



MAURER SRFL model

The MAURER Architectural Expansion Joint System SRFL is capable of accommodating multidirectional seismic movements without imposing stress on its components. The aluminum roof cover is designed for flat or sloped roofs with expansion joints subjected to thermal and seismic movements. The SRFL system's seismic self-centering mechanism allows the sliding plate to return to its initial position after an earthquake.

>> Parking / Landscape Joints < 85 mm

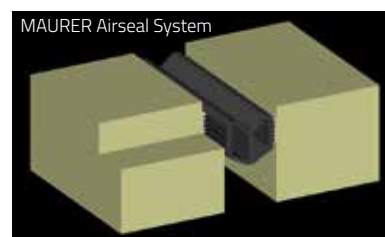

The MAURER Airseal System is a structural sealing joint comprised of EPDM / neoprene tube profile, which is pressurized and bonded with epoxy resin. A reliable bonding of the profile to the structure is achieved through air inflation during installation. MAURER Airseal is a very durable, versatile, cost-effective and watertight system.

The MAURER Airseal System is a structural sealing joint comprised of EPDM / neoprene tube profile, which is pressurized and bonded with epoxy resin. A reliable bonding of the profile to the structure is achieved through air inflation during installation. MAURER Airseal is a very durable, versatile, cost-effective and watertight system.

References



>> Botlekbrug, Rotterdam / Netherlands 🚗 🚚

Task:

Opening and closing the largest lift bridge in Europe presented a technical challenge. Thus special bearings and roadway joints were required which MAURER has developed specifically for this purpose.

Scope of project:

16 MAURER Spherical Bearings across the slip plane which can be opened. In contrast to the expansion joints, the plain bearings remain on the abutments and only the second plane moves upwards. The spherical bearings measure approx. 1,200 x 1,100 mm and weigh more than 4 t. The loads are 21,000 to 29,000 kN.

The Botlekbrug is the entrance to the largest seaport in Europe and currently the largest lift bridge in Europe. It is part of a 37 km highway section of the A15 passing through Rotterdam.

>> Hong Kong Zhuhai Macao Bridge / China 🚗 🚚

Task:

MAURER developed special joints with steel connections at both ends. The 700 m long Jianghai Bridge is part of the Hong Kong Macao highway connection crossing the Pearl River delta.

Scope of project:

MAURER Swivel Joist Expansion Joints with a movement capacity of 1,760 or 1,200 mm, respectively.



>> Russky Bridge, Vladivostok / Russia 🚗 🚚

Task:

Structural protection against wind and earthquakes on currently the widest spanning cable-stayed bridge in the world with a pylon distance of 1,104 m.

Scope of project:

MAURER Swivel Joist Expansion Joints for 2.4 m of movement and anti-skid surface (XLS 2400). MAURER MSM® Spherical Bearings (KGA, KGE) with 34 MN superimposed load and MAURER Horizontal Force Bearings plus 25MN horizontal force, MAURER Hydraulic Wind / Earthquake Dampers (MHD) for 3 MN and 2.2 m of movement and passive / adaptive cable-stayed dampers for cables up to a length of 578 m.



Quality Control

⇒ Quality control

- Abstract of fulfilled technical assessments
 - TL/TP FÜ "German specification for watertight lamella- and cantilever expansion joints"
 - ETAG 032 "Guideline for European Technical Approval for expansion joints for road bridges"
 - AASHTO LRFD Bridge Design Specification
- DIN EN ISO 9001 "Quality management systems"
- EN 1090 "Execution of steel structures and aluminium structures"
- DBS 918005 EXC3DB
- CE marking
- European Technical Approval for MAURER XW1 Expansion Joint, ETA-13/0232
- Certification by Deutsche Bahn, Germany
- Testing by independent universities and notified bodies



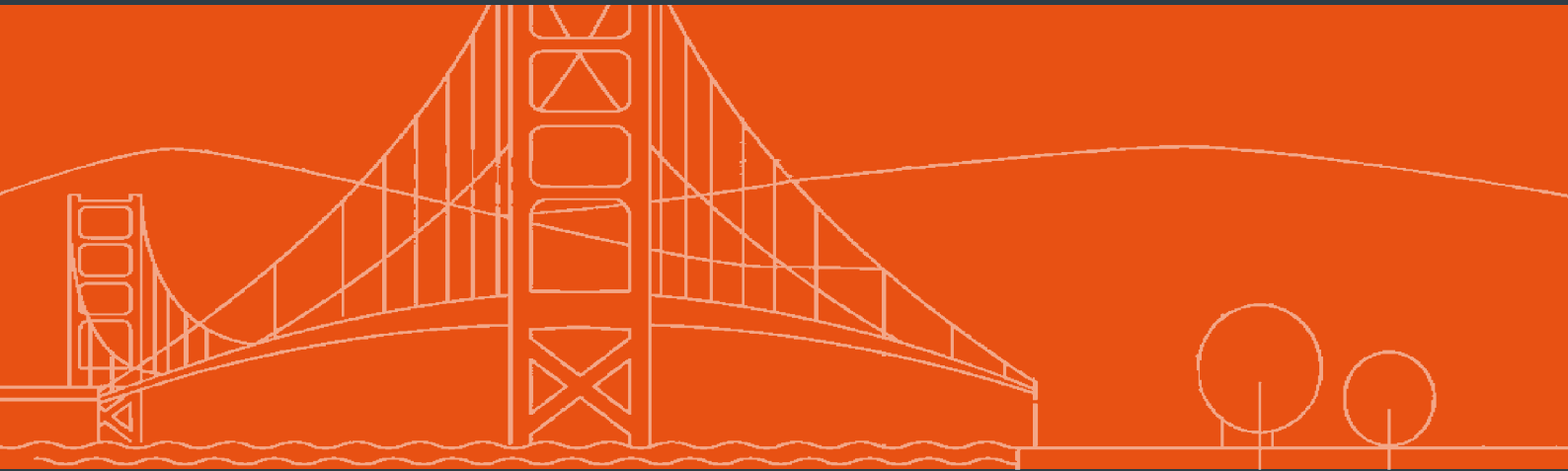

MAURER SE

Frankfurter Ring 193
80807 Munich
Germany

P.O. Box 440145
80750 Munich
Germany

Phone +49.89.323 94-0
Fax +49.89.323 94-306

info@maurer.eu
www.maurer.eu

German Engineering since 1876

